

COBRA ELITE 6 X 12

STANDARD MACHINE

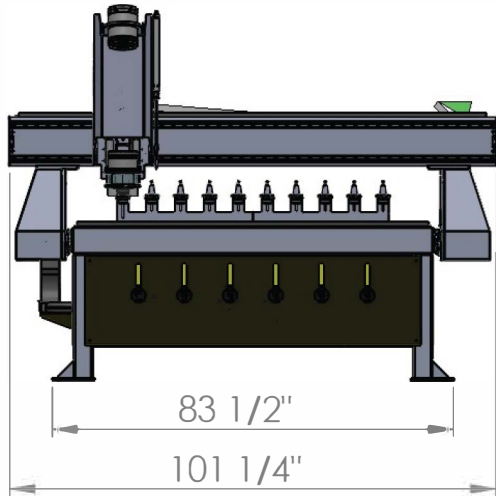

ATC T2/T3 MACHINE

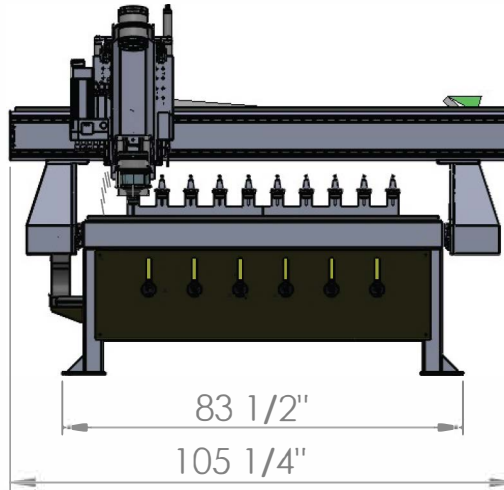

ATC CAROUSEL MACHINE

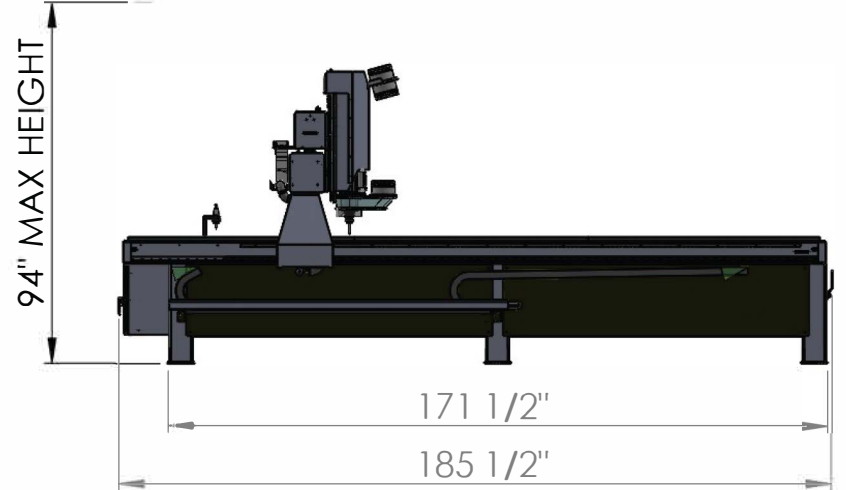
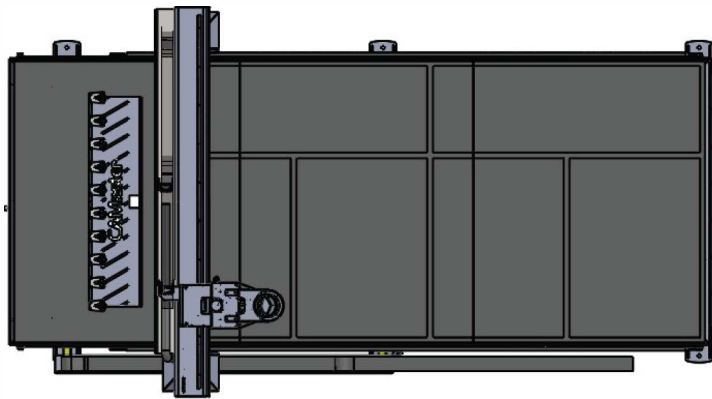
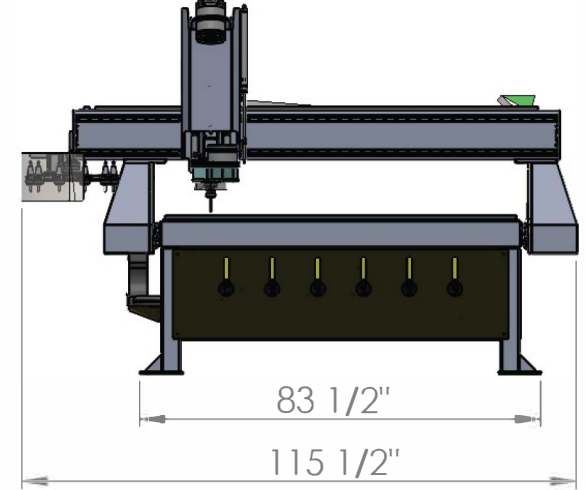

T2/ T3 OPTIONS

- DRILLBANK
- TANGENTIAL KNIFE
- VISION REGISTRATION

CAMaster

PART:
CE
CONFIGURATION: Linear ATC 612
DRAWING: Cobra 6x12 Machine Layout