

COBRA ELITE 5 X 5

STANDARD MACHINE

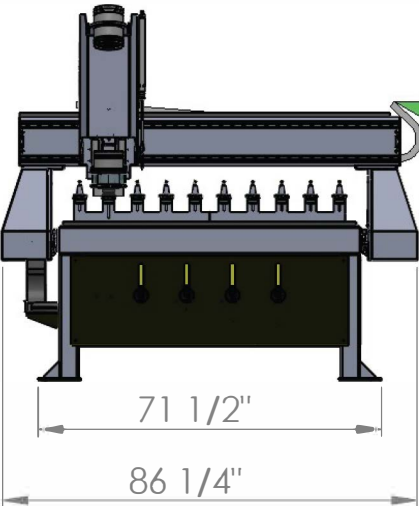

ATC T2/T3 MACHINE

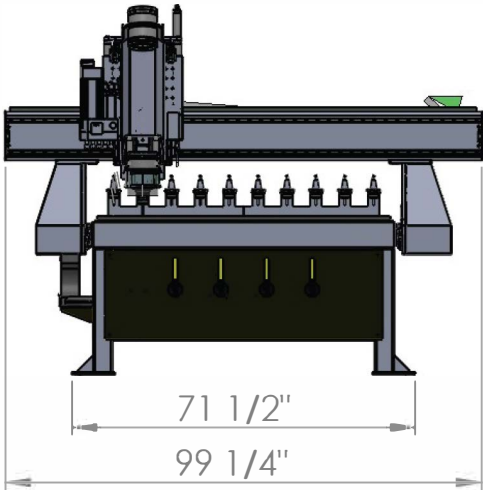

ATC CAROUSEL MACHINE

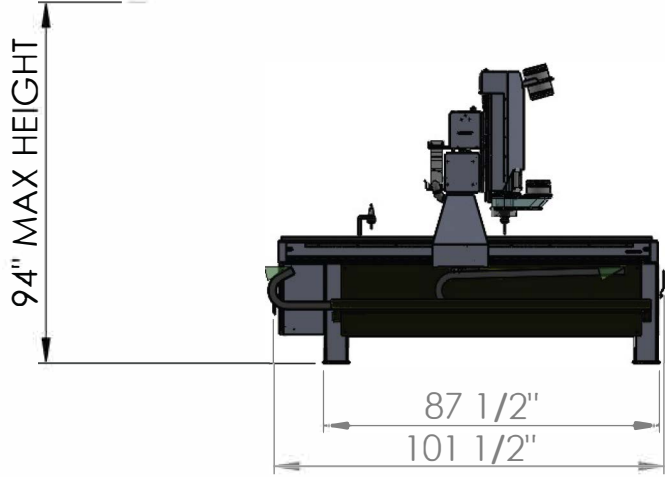
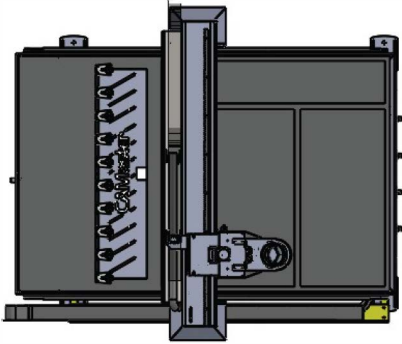
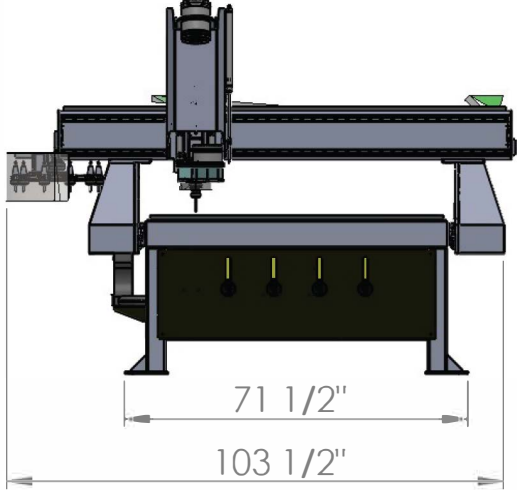

T2/ T3 OPTIONS

- DRILLBANK
- TANGENTIAL KNIFE
- VISION REGISTRATION

CAMaster

PART:
CE
CONFIGURATION: Linear ATC 505
DRAWING: Cobra 5x5 Machine Layout